

UP-ONE





01

Overview

Development Background





Sitting too long is like the most silent suicide





Harm for people of sitting too long

- Obesity

Sitting too long → consuming little calorie- → fat piles up → gaining weight



- Memory Deterioration

Sitting too long → blood circulation slows down → not enough blood supply to brain → stressed out (tiredness, in low spirit, yawning too m



- Lumbar Spondylosis

Sitting too long → all weight on the bottom of spine & stiff shoulder and neck → stiff cervical vertebra & deformity of spine & kyphosis and hyperostosis



- Inappetence

Sitting too long → lacking exercise → inhibit gastrointestinal peristalsis & less digestive juice → anorexia & d





The concerns of health drive us to
change.



Sit-To-Stand Working Mode

Benefits from sit-to-stand working mode

- ✓ Smoother blood circulation
- ✓ Mode energetic
- ✓ Stronger metabolism
- ✓ Prevents Lumbar Spondylosis , myopia, cervical spondylosis, scapulohumeral periarthritis, prostatic calculus, gynecological disease
- ✓ Help consume more calories and prevent obesity





Exhausted from sitting? Let's stand up!



UP ONE

Starting sit-to-stand movement among employees.



02

Features

Configuration

Function

Family Collection

Routing System

Color Option

Materials

Warranty



Configuration

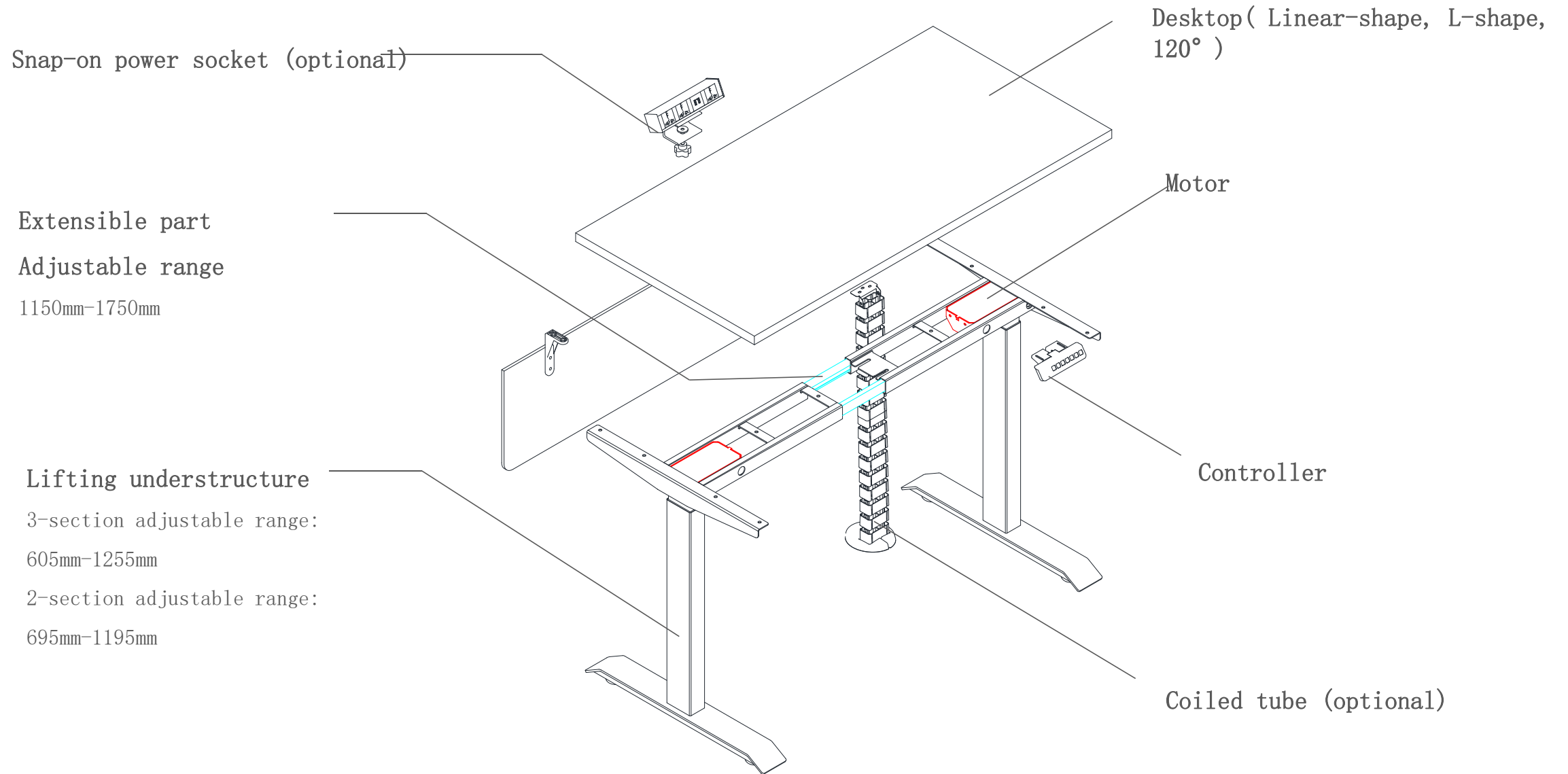



Desktop

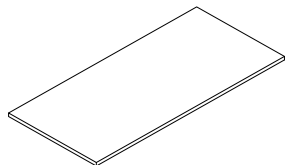

Linear-shape desktop

1200*600/750*25
1400*600/750*25
1500*600/750*25
1600*600/750*25
1800*600/750*25

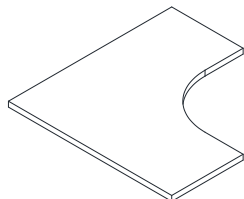

L-shape desktop

1500*1500*600*600
1600*1600*600*600

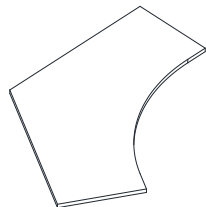

120° desktop

1400*1400*750*750

Wire System

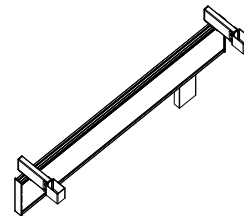

Single workstation
desk wire system

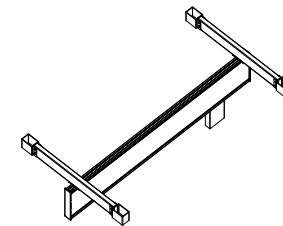

Double workstation desk
wire system

Lifting understructure

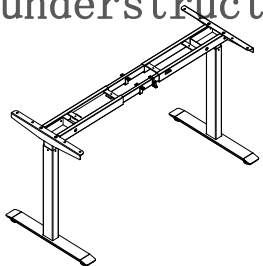

2-section:
695mm-1195mm
3-section
605mm-1255mm

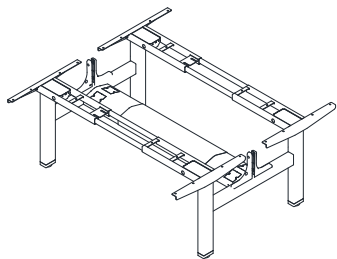

2-section:
695mm-1185mm
3-section
605mm-1245mm

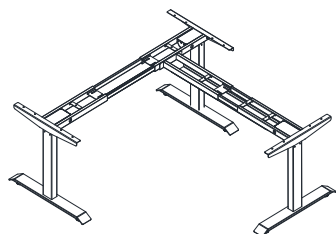

2-section:
695mm-1185mm
3-section
605mm-1245mm

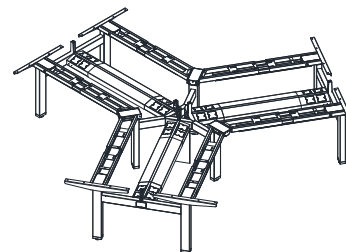

2-section:
695mm-1185mm
3-section
605mm-1245mm

CPU holder

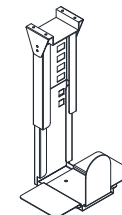

Snake tube

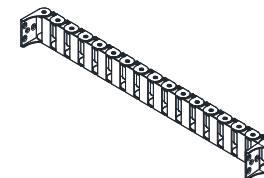

Multiple power sockets



American standard



British standard



Australian standard



European standard

Function

Dual-motor for better performance

2-section Understructure

1. Height range: 695~1185mm
(Without desktop 25mm)
2. Speed: 30mm/s
3. Noise \leq 50db
4. Voltage: 100V-240V
5. Wall thickness: 1.5mm-2mm



3-section Understructure

1. Height range: 605~1245mm
(Without desktop 25mm)
2. Speed: 38mm/s
3. Noise \leq 50db
4. Voltage: 100V-240V
5. Wall thickness: 1.5mm-2mm

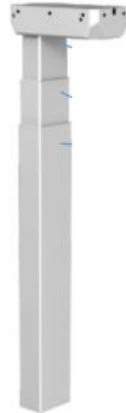

120kg load capacity during the lifting operation.



Function



◆ Three heights can be memorized.

Set preferred heights for sitting and standing postures..

◆ Silient lift

<46db, minimize office noise and focus on work

◆ High speed

30-38mm/s speed, achieving the designated height within 13s with a quick response

◆ Retreat upon obstacle

Automatic ascend or descend when there is an obstacle(click video beside).

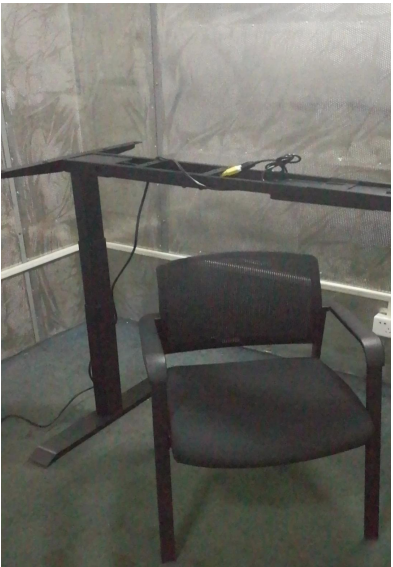

Family collection



Staff workstation

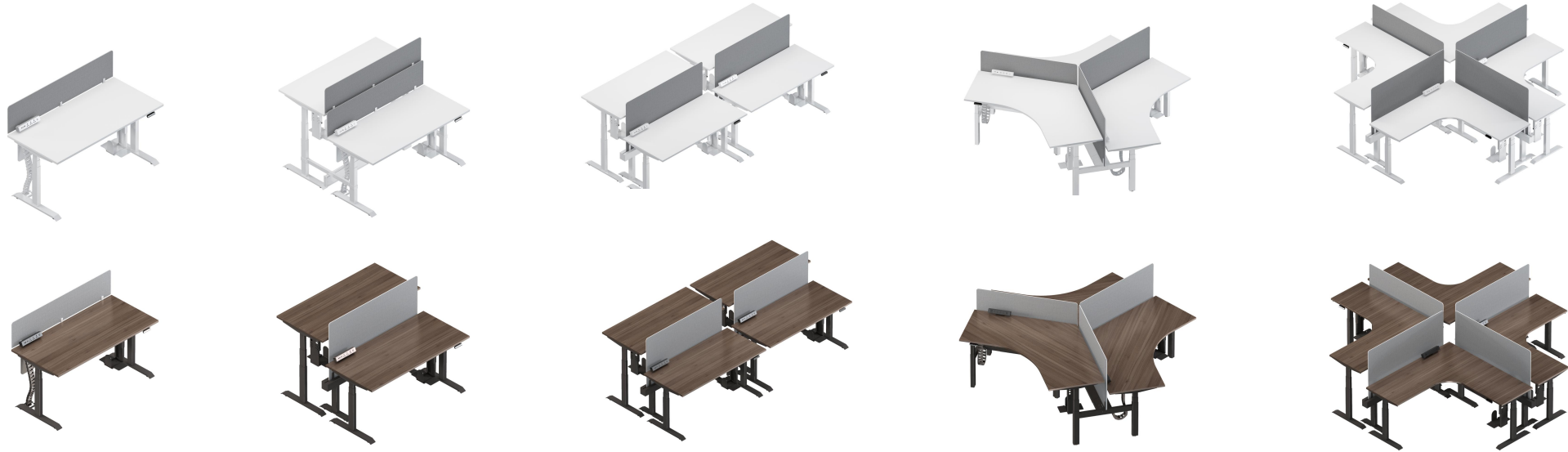

Manager desk



Staff Space Solution



Combinations

Linear desktop



120° desktop



L-shape desktop

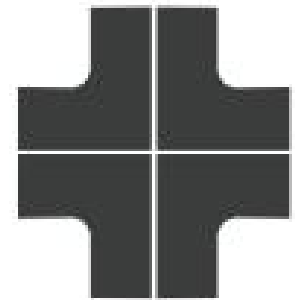
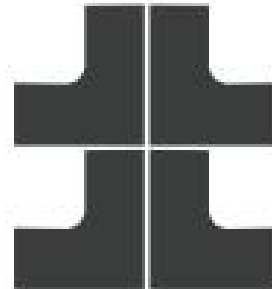
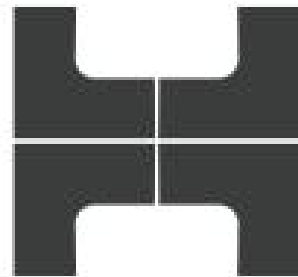
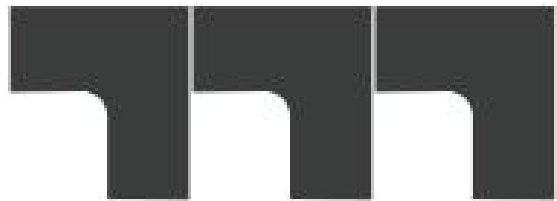

Staff Space



Staff Space



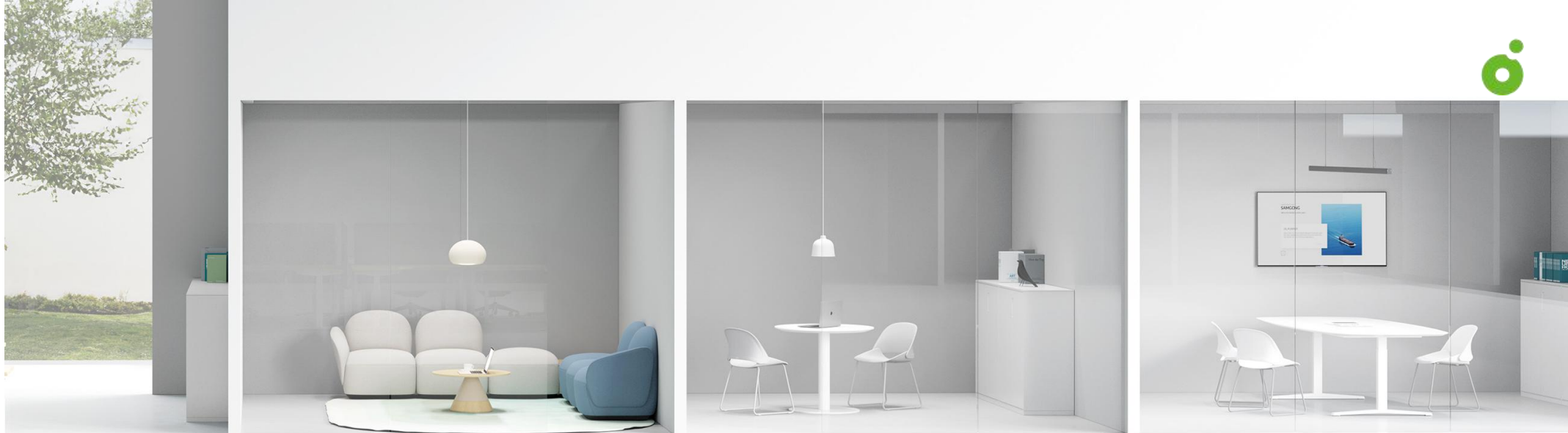

Staff Space



Manager Space Solution



Manager Desk

DZZ80L-2. 180182

Size:1800*1820*720-1210MM

CBM(m³) : 0.66



Manager Space

Routing System for staff workstation



Independent routing system

Available for dual-workstation and L-shape workstation

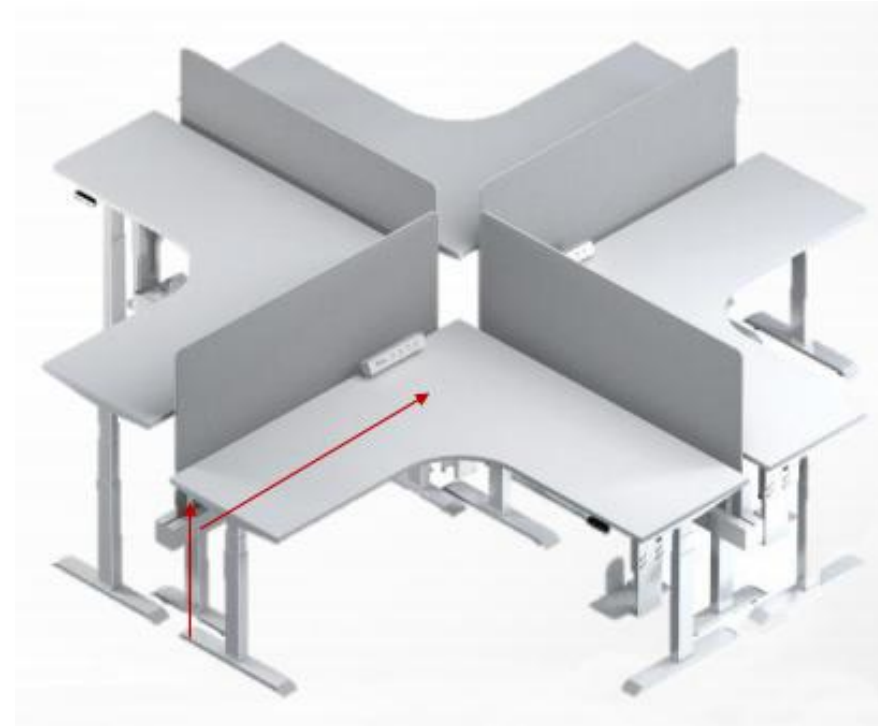

Steel feet connects to the ground plug, cables pass through the beam and combined with snake tube.

Routing System for staff workstation



Dual-desk routing system



Steel base integrated lifting and routing functions, combined with vertical cable box and snake tube.

Routing System for staff workstation



Crossbeam routing system

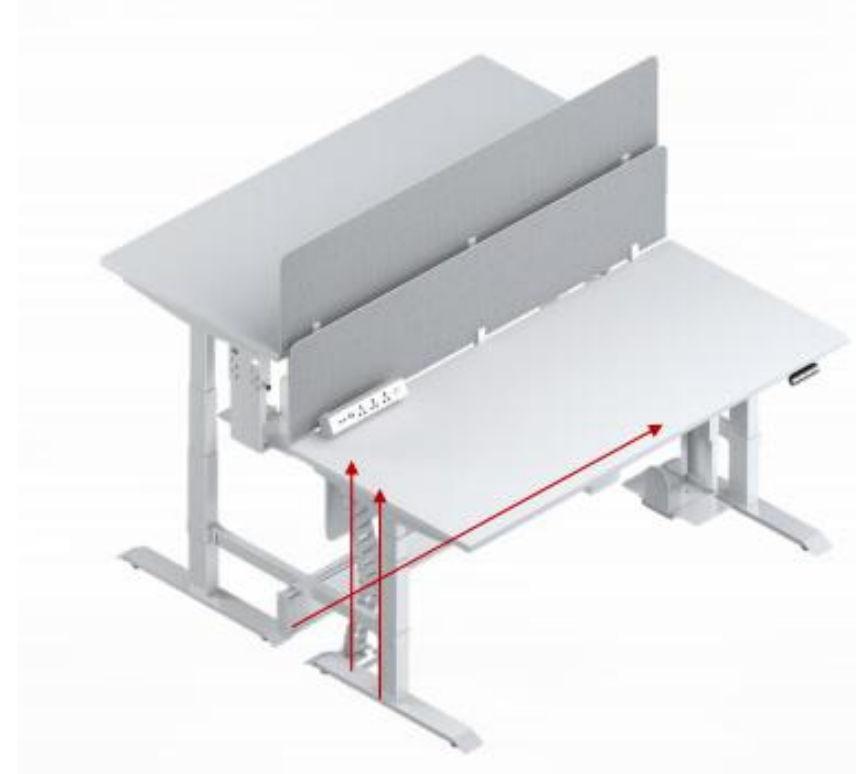

Cables pass through crossbeams and combine with snake tube.

Routing System for manager desk



Cables pass through the snake tube and connect with the socket.

Color Option



Desktop

Featured color



S-57 White



S-56 Castin oak



S-77 White oak

Optional color

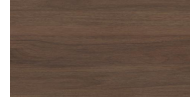

S-53 Felix
walnut



S-43 Cass walnut



S-66 Eucalyptus



S-37 Virginia walnut

Modesty panel/Screen

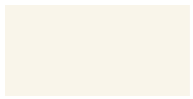

S-57 White



S-59 Meteor grey

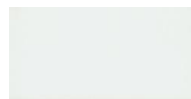

Matte white



Matte black



Meteor grey

Understructure

Coiled tube



White



Black

Power socket



White



Black



Materials



Desktop			Motor		Frame					Accessories	
Item	Basic material	Thickness	Voltage	Power	Basic material	Thickness	Manufacturing technique	Coating technique	Coating thickness	Material of modesty panel	Thickness of modesty panel
Specification	MDF/PB	25mm	110V-240V	Maximum power output 70W	steel	3mm	Welding assembly	Powder coating	70-120um	MDF	8MM

Warranty



UP One desk is warranted for 5 years from the date of delivery.
(not apply to product failure from modification, abuse and shipping damage).



TÜVRheinland®



Sample Information

Overall dimension: 1502 mm (L)×1500 mm (W)×1288 mm (H)
Weight: 106.22 kg

Test Report

No.: AJHL2006001289FT

Date: JUN 24, 2020

Page 10 of 10

Photo Appendix



Sample as received - View 1



Sample as received - View 2



Sample as received - View 3



Sample as received - View 4



Sample as received - View 5



Sample as received - View 6

SGS authenticate the photo on original report only

UP One passes BIFMA and CE test.